



A division of Terry Young Ltd, New Zealand

INSTALLATION INSTRUCTIONS for MONTE MULTI-FUEL & MONTE EURO MULTI-FUEL FREESTANDING BURNER

APPLIED RESEARCH TEST REPORT 12/2514 APRIL 2012

TESTED in compliance with the requirements of AS/NZS 2918:2001

The Yunca Monte Multi-Fuel and Monte Euro Multi-Fuel are NOT clean-air approved.

- A.** Yunca recommends that competent trades persons carry out all installations (e.g. NZHHA Registered Installer), to obtain maximum performance and safe, efficient heating.
- B.** A permit is required and we suggest you check with local building inspectors as by-laws do vary from area to area.
Also notify your Insurance Company that a solid fuel heater has been installed.
- C.** Ash Floor Protector –
1. Must extend a minimum of 300mm in front of the door aperture.
 2. Must extend at least 125mm from each side of the heater.
 3. Ash Floor Protector must be constructed of non-combustible materials.
- D.** Seismic restraint – Heater must be restrained from seismic movement as required by AS/NZS 2918:2001. 10mm diameter bolting holes in the rear corners allow restraint.
- E.** Manufacturers recommended tested minimum clearances from combustible walls:

Tested to NZS by APPLIED RESEARCH SERVICES	Clearance
Rear Clearance (with YUNCA flue guard fitted)	150mm
Side Clearance (with YUNCA flue guard fitted)	400mm
Corner Clearance (with YUNCA flue guard fitted)	200mm

F. YUNCA Flue Kit (Complies to AS/NZS 2918:2001 Appendix F): FIG A, B & E

1. 4.2m x 150mm stainless steel flue.
2. 2.4m x 250mm galvanised liner.
3. 1 x ceiling tile.
4. 1 x insulation boundary shield.
5. 2 x spider brackets.
6. 1 x weather cap & cowl.
7. 4 x support angles

Please Note: All joints must be sealed with flue sealing compound. Use stainless steel screws or rivets to join the flue pipe (three equally spaced places at each joint). The first length of flue pipe must be screwed to flue spigot. The required minimum flue termination height is 4.6 m above the floor protector.

G. MULTI-FUEL & EURO MULTI-FUEL Flue Mounted Shield (Flue Guard) Kit: FIG A

Complies (with heater) to AS/NZS 2918:2001

- 1 x 1200mm length lined Back Guard.
- 1 x 1200mm length Perforated Front Guard.
- 1 x 1200mm length Tertiary Back Guard with spacers.
- 1 x top front deflector shield (half round shaped, angled when installed).

Please Note: The minimum Flue Guard Height is 1200mm.

MONTE MULTI-FUEL & MONTE EURO MULTI-FUEL – TYPICAL FLUE INSTALLATION

(drawings on the following pages not drawn to scale)

FIG A MONTE MULTI-FUEL & MONTE EURO MULTI-FUEL Flue Mounted Shield (Flue Guard) Kit Installation

Complies (with heater) to AS/NZS 2918:2001

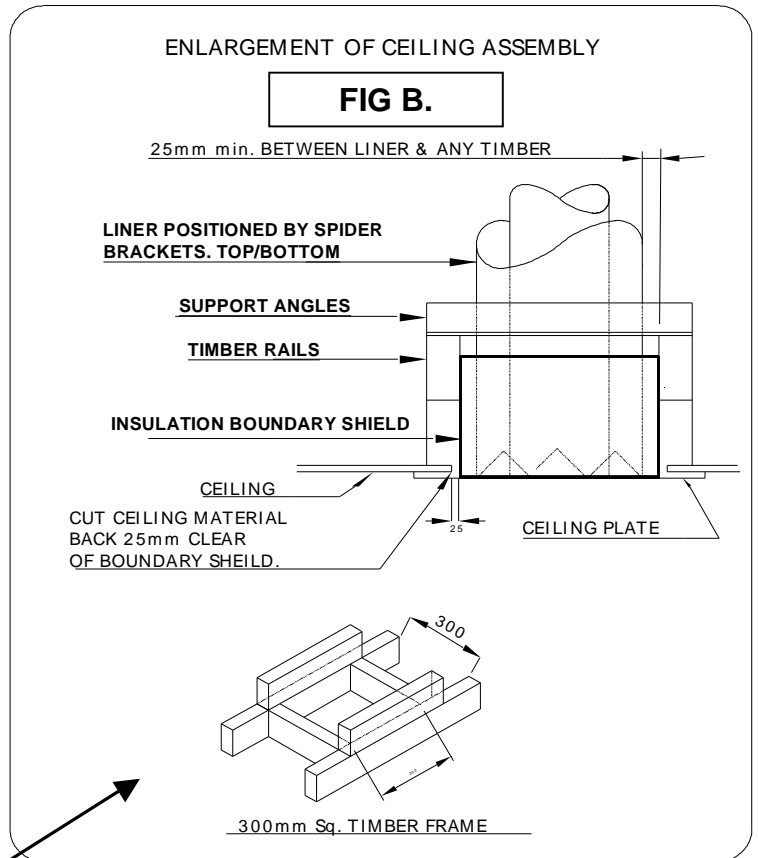
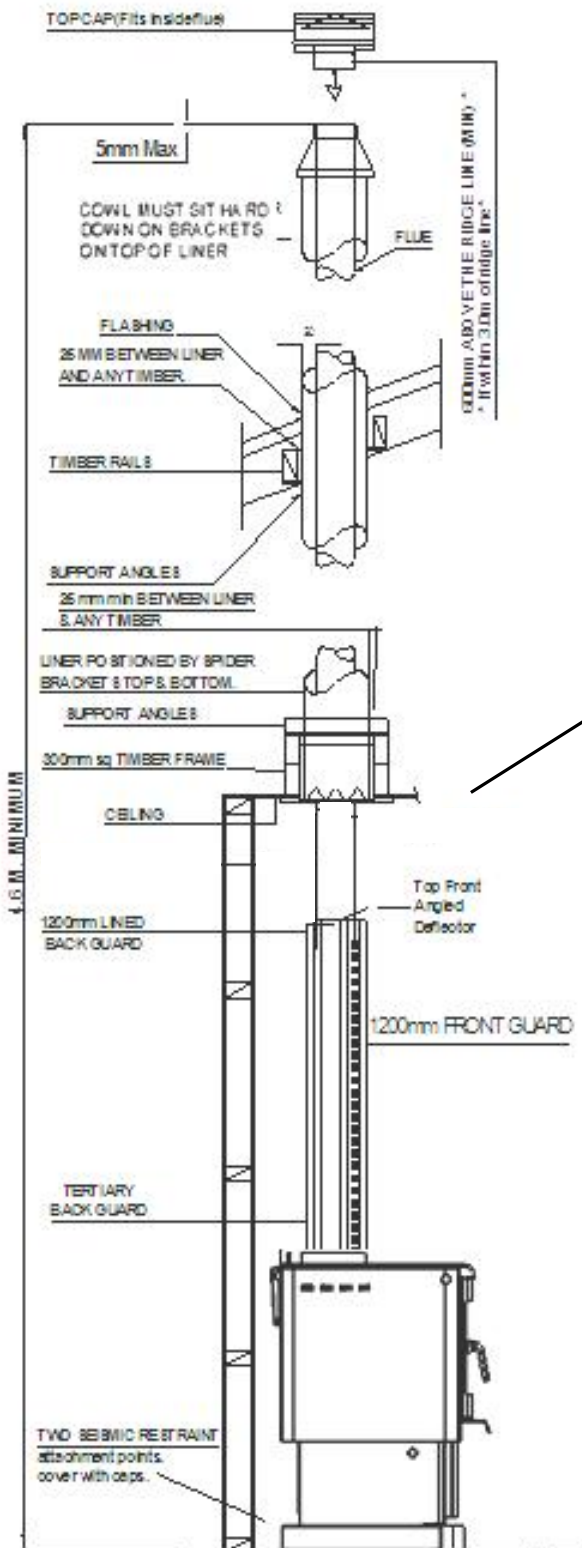

CONDITIONS FOR FLUES (Refer Fig. E)

1. The FLUE shall extend to:

Not less than 600mm above the highest point on the roof if within 3.0m of that point, or
 Not less than 1000mm above the intersection point with the roof and not lower than any point of the roof within 3.0m.

In any case the length of the flue shall not be less than 4.6m from the ash floor protector.

In some situations the Local Council may vary the above requirements.

2. The flue system must be tested and comply with AS/NZS2918:2001, Appendix F.
3. The insulation boundary shield shall be capable of preventing accidental migration of loose-fill or any combustible material by any action of wind or by persons moving in the ceiling space.

Note! All Dimensions are in millimetres

These instructions spare parts information, operation and maintenance guides may be downloaded from www.yunca.co.nz

FIG. C: HEATER DIMENSIONS & WATER BOOSTER POSITION – Monte MF & Euro MF

(not to scale)

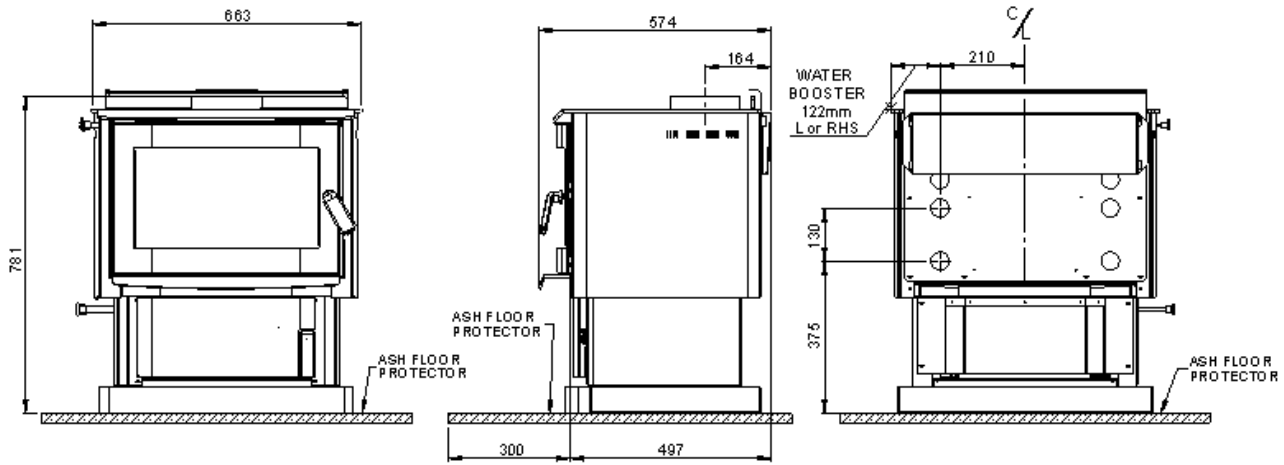
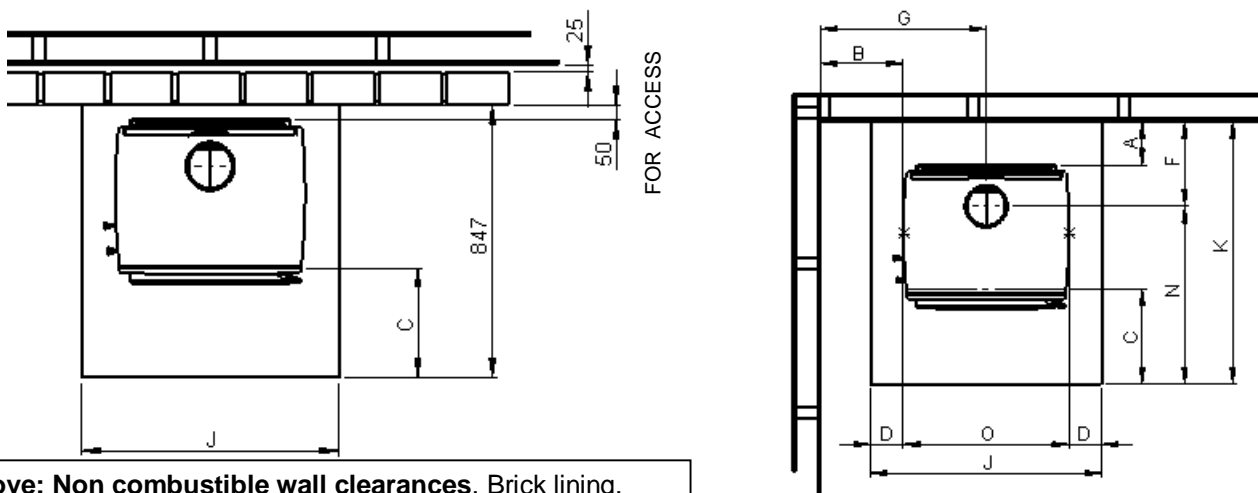

FIG.D: HEATER POSITION. (Not to scale)



Above: Non combustible wall clearances. Brick lining. From the floor to within 25mm of ceiling. Leave air vents at the bottom to allow airflow in the cavity. If Yunca flue mounted shield is fitted, brickwork may be 1200mm high as long as all vertical joints in top and bottom of brickwork are left out to allow airflow when brickwork is capped.

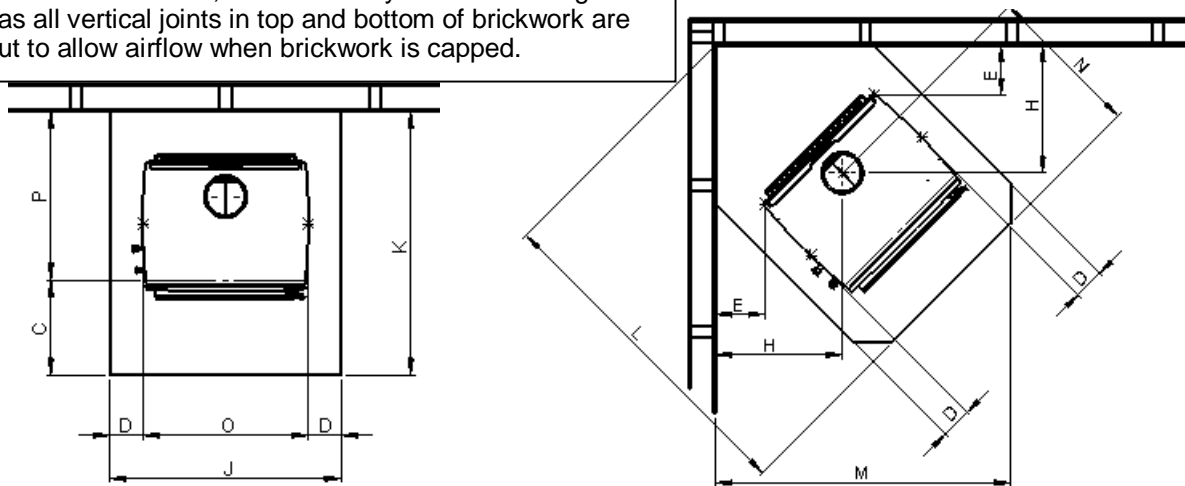

FIG D: MINIMUM FIRE TO COMBUSTABLE WALL CLEARANCES – MONTE MF & Euro MF (WITH YUNCA FLUE MOUNTED SHIELD FITTED). Measurements in millimetres.

A	B	E	F	G	H
150	400	200	314	732	519

FIG D: MINIMUM FLOOR PROTECTION MEASUREMENTS (WITH YUNCA FLUE MOUNTED SHIELD FITTED). Measurements in millimetres.

C	D	J	K	L	M	N	O	P
300	125	913	947	1367	1208	633	663	647

FIG E: FLUE SYSTEM REQUIREMENTS (not to scale)

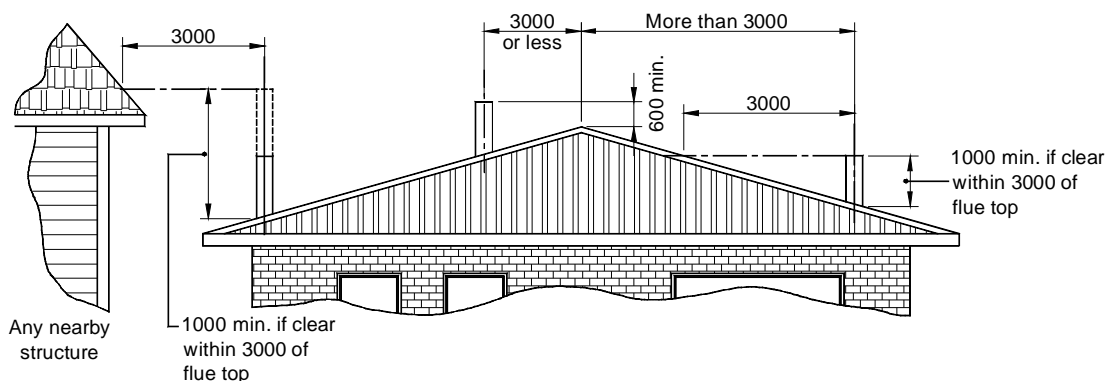

NOTE : Dimensions are in millimetres

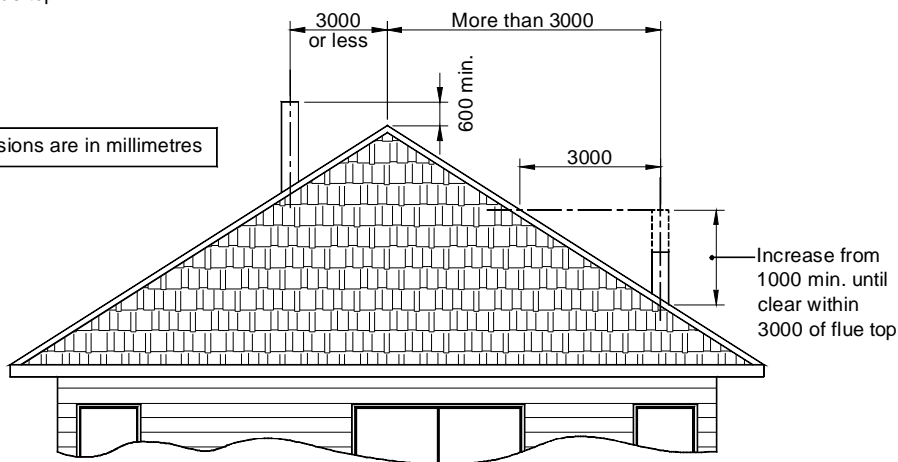

MINIMUM HEIGHT OF FLUE SYSTEM EXIT

IMPORTANT INFORMATION

- A. The appliance and flue system shall be installed in compliance with AS/NZS 2918:2001 and the appropriate requirements of the relevant building code or codes.
- B. Mixing of appliance or flue system components from different sources or modifying the dimensional specification of components may result in hazardous conditions. Where such action is considered, the manufacturer should be consulted in the first instance.
- C. Cracked and broken components e.g. glass panels or fire bricks, may render the installation unsafe.

IF A WATERBOOSTER IS FITTED:

- A. Do not connect to an unvented hot water system
- B. Install in accordance with AS 3500.4.1 or NZS 4603 and the appropriate requirements of the relevant building codes.

Seismic Restraint

Secure the heater base to the hearth or sub-framing with Dynabolts or similar, through the holes provided in the heater base.

Follow local Council's Specifications.

The Yunca Monte Multi-Fuel and Monte Euro Multi-Fuel are NOT clean-air approved.